

Varenummer: 4320000301  
Beskrivelse: Rota-fix spændelement A 30x55  
Rustfast stål

## Mål

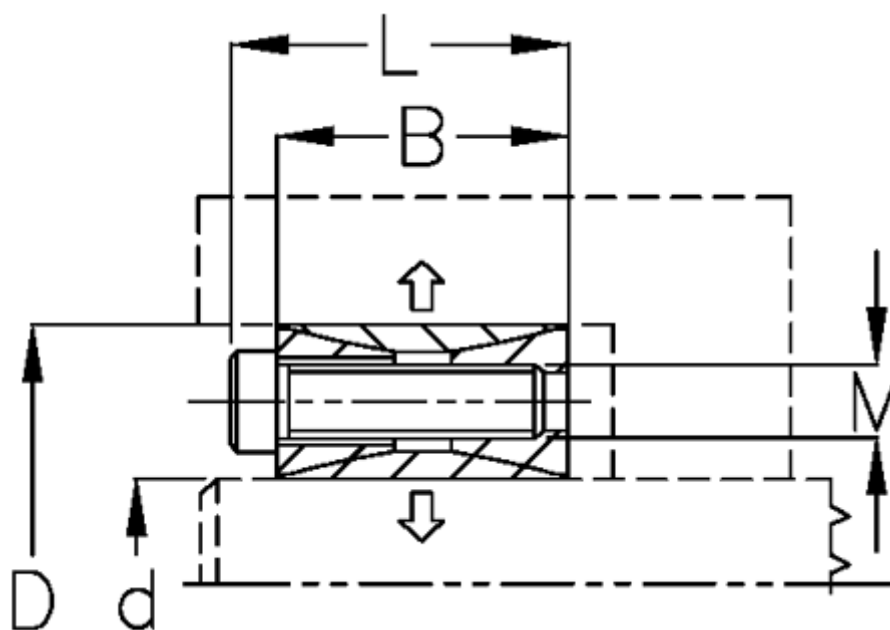

B mm	= 20
d H8 mm	= 30
D mm	= 55
F kN aksialkraft	= 20.6
L mm	= 26
M mm	= M6
Overfladeruhed	= R? ? 3.2 $\mu$ m
P N/mm <sup>2</sup> fladetryk på aksel/nav	= 34

T Nm drejningsmoment	= 310
Tolerance	= Aksel k11-h11, Nav M6
Ts Nm boltetilspændingsmoment	= 8.8